

LIBERTY

LIBERTY





Finitura: Patinato Beige - Top: Verde Guatemala
Finishing: Coated Beige - Top: Verde Guatemala





Finitura: Patinato Bianco - Top: Bianco Aosta
Finishing: Coated White - Top: Bianco Aosta







Finitura: Patinato Beige - Top: Botticino
Finishing: Coated Beige - Top: Botticino



FINITURE ANTA / DOOR FINISHING

ANTA DOOR	
	
ANTA patinato bianco DOOR coated white	ANTA patinato beige DOOR coated beige

MANIGLIE / HANDLES

M



M finitura CROMO e ORO
M CHROME finish and GOLD

FINITURA ZOCCOLO / SKIRTING FINISHING



Legno patinato bianco / patinato beige H. 10 cm
Coated white wood / coated beige wood H. 10 cm

CORNICE SUPERIORE / TOP FRAME



Legno patinato bianco / patinato beige H. 4 cm
Coated white wood / coated beige wood H. 4 cm

DISEGNO TECNICO / TECHNICAL SCHEME

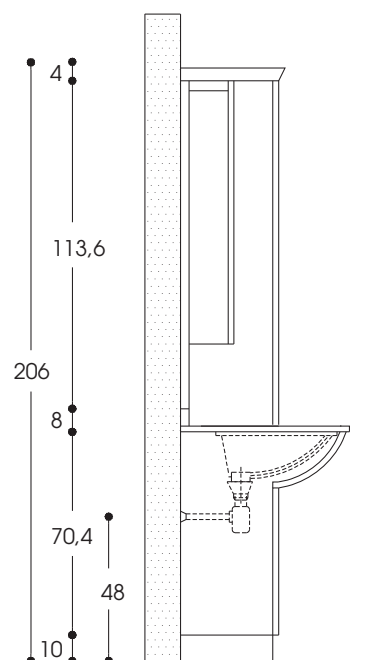

BASI PORTALAVABO SEMINCASSO P. 34
SEMI-RECESSED WASHBASIN UNITS P. 34

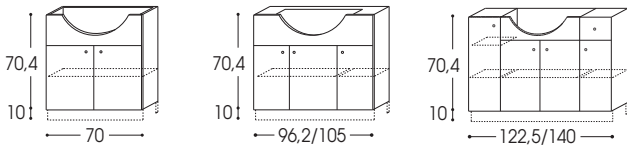

BASI PORTALAVABO INCASSO TOTALE P. 34/57
RECESSED WASHBASIN UNITS P. 34/57

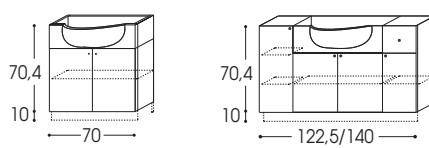

BASE PORTALAVABO
INCASSO TOTALE P. 34/48,5
RECESSED WASHBASIN
UNITS P. 34/48,5

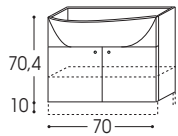

BASE PORTALAVABO
INCASSO TOTALE P. 34/60
RECESSED WASHBASIN
UNITS P. 34/60

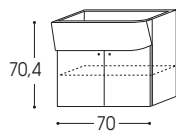

da affiancare alla
base p.lavatrice P. 60
to put beside the
washing-machine
unit D. 60

BASI TERMINALI
TERMINAL UNITS

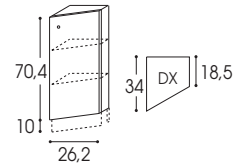

BASI P. 34
BASES P. 34

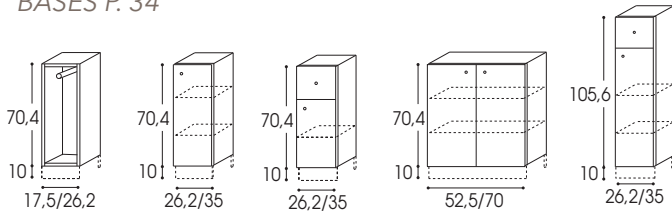

BASI PORTALAVATRICE
WASHING MACHINE UNITS

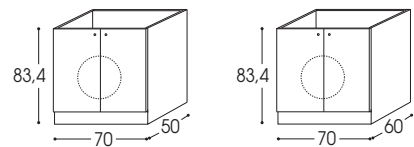

COLONNA PORTALAVATRICE
WASHING MACHINE COLUMN

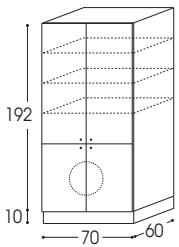

COLONNE P. 34
COLUMNS P. 34

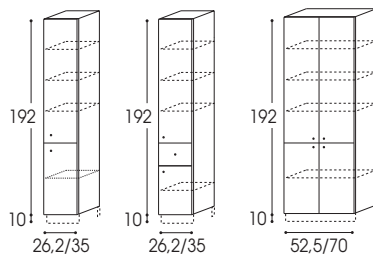

PENSILI CON VANETTO P. 18,5
WALL UNITS WITH COMPARTMENTS P. 18,5

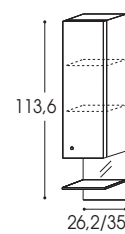

PENSILI P. 18,5
WALL UNITS P. 18,5

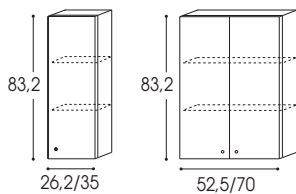

VANETTI A SPECCHIO
MIRROR COMPARTMENTS

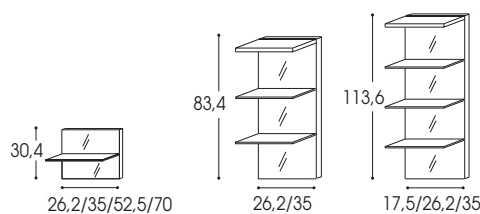

SPECCHI CON MENSOLE P.18,5
MIRRORS WITH SHELVES D.18,5

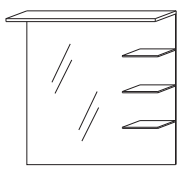

87.5/96.2/105/113.7/122.5/131.2/140

SPECCHI CON PENSILE P.18,5
MIRRORS WITH HANGING UNIT D.18,5

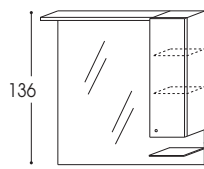

122.5/140

SPECCHI P.18,5
MIRROR P.18,5

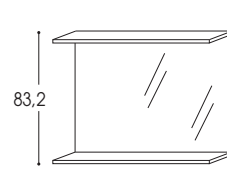

70/87.5/96.2/105/113.7/122.5/131.2/140

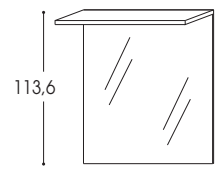

70/87.5/96.2/105/113.7/122.5/131.2/140/148.7/157.5/166.2

BASI PORTALAVABO SEMINCASSO a terra o sospese, **PROFONDITÀ 34 CM**
Floor or suspended SEMI-RECESSED WASHBASIN UNITS, 34 CM DEPTH

	Larghezza (cm)	Articolo	Prezzo
	Width (cm)	Code	Price

Altezza fianchi / Sides height 70,4 cm

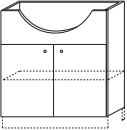
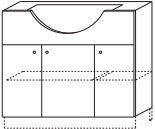
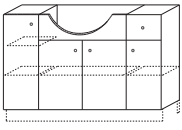
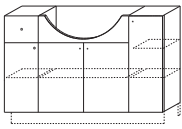
 <p>due ante two doors</p>	70	LCLM12D2	€ 553
 <p>tre ante three doors</p>	96,2	LCLM13I2	€ 758
	105	LCLM13E2	€ 895
 <p>quattro ante / un cassetto a dx four doors / one right drawer</p>	122,5	DCLM11F2	€ 1.022
	140	DCLM11G2	€ 1.130
 <p>quattro ante / un cassetto a sx four doors / one left drawer</p>	122,5	SCLM11F2	€ 1.022
	140	SCLM11G2	€ 1.130



BASI PORTALAVABO A TERRA CON ZOCCOLO H. 10 O SOSPESSE CON BARRA DI SOSTEGNO. Specificare al momento dell'ordine.
 Il prezzo dello zoccolo o della barra di sostegno è compreso nel prezzo del mobile.
 FLOOR WASHBASIN UNITS WITH BASE H. 10 OR SUSPENDED WITH SUPPORT BAR. Specify when ordering.
 The price of the base or the support bar is included in the unit price.

BASI PORTALAVABO INCASSO TOTALE a terra o sospese, **PROFONDITÀ 34/57 CM**
 Floor or suspended **FULLY-RECESSED INTEGRATED WASHBASIN, 34/57 CM DEPTH**

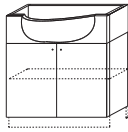
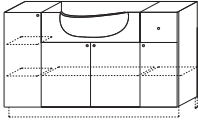
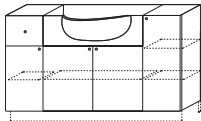
	Larghezza (cm)	Articolo	Prezzo
	Width (cm)	Code	Price
Altezza fianchi / Sides height 70,4 cm			
 due ante two doors	70	LCLM92D2	€ 751
 quattro ante / un cassetto a dx four doors / one right drawer	122,5	DCLM91F2	€ 1.271
	140	DCLM91G2	€ 1.384
 quattro ante / un cassetto a sx four doors / one left drawer	122,5	SCLM91F2	€ 1.271
	140	SCLM91G2	€ 1.384

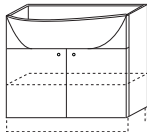
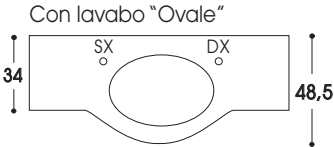

BASI PORTALAVABO INCASSO TOTALE a terra o sospese, **PROFONDITÀ RIDOTTA 34/48,5 CM**
 Floor or suspended **FULLY-RECESSED INTEGRATED WASHBASIN, 34/48,5 CM REDUCED DEPTH**

 due ante two doors	70	LCLMN2D2	€ 751
 <p>Con lavabo "Ovale"</p>	<p>ATTENZIONE / ATTENTION:</p> <p>Utilizzando il lavabo "Ovale" il foro rubinetto è posizionato a dx o a sx rispetto al foro lavabo. When using the "Ovale" washbasin the hole for the tap is on the left or right side of the washbasin tap.</p>		

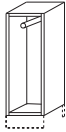
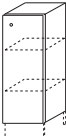
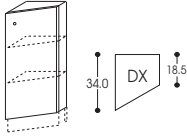

BASI PORTALAVABO A TERRA CON ZOCCOLO H. 10 O SOSPESE CON BARRA DI SOSTEGNO. Specificare al momento dell'ordine.
 Il prezzo dello zoccolo o della barra di sostegno è compreso nel prezzo del mobile.
 FLOOR WASHBASIN UNITS WITH BASE H. 10 OR SUSPENDED WITH SUPPORT BAR. Specify when ordering.
 The price of the base or the support bar is included in the unit price.

BASI a terra o sospese, **PROFONDITÀ 34 CM**
 Floor or suspended BASES, **DEPTH 34 CM**

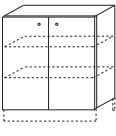
	Apertura	Larghezza (cm)	Articolo	Prezzo
	Opening	Width (cm)	Code	Price
Altezza fianchi / Sides height 70,4 cm				
 portasalviette towel rail	-	17,5	LCLB2EA2	€ 288
	-	26,2	LCLB2EB2	€ 348
 un'anta one door	cerniere destra right hinges	26,2	DCLB21B2	€ 302
	cerniere sinistra left hinges		SCLB21B2	
	cerniere destra right hinges	35	DCLB21C2	€ 340
	cerniere sinistra left hinges		SCLB21C2	
 terminale un'anta one door terminal	cerniere destra right hinges	26,2	DCLQ11B2	€ 313
	cerniere sinistra left hinges		SCLQ11B2	
 un'anta / un cassetto one door / one drawer	cerniere destra right hinges	26,2	DCLB24B2	€ 338
	cerniere sinistra left hinges		SCLB24B2	
	cerniere destra right hinges	35	DCLB24C2	€ 373
	cerniere sinistra left hinges		SCLB24C2	
 due ante two doors	-	52,5	LCLB22N2	€ 476
	-	70	LCLB22D2	€ 531

BASI a terra o sospese, **PROFONDITÀ 34 CM**
 Floor or suspended BASES, **DEPTH 34 CM**

	Apertura	Larghezza (cm)	Articolo	Prezzo
	Opening	Width (cm)	Code	Price
Altezza fianchi / Sides height 105,6 cm				
 un cassetto / un'anta h. 83,2 one drawer / one door h. 83,2	cerniere destra right hinges	26,2	DCLB24B4	€ 455
	cerniere sinistra left hinges		SCLB24B4	
	cerniere destra right hinges	35	DCLB24C4	€ 538
	cerniere sinistra left hinges		SCLB24C4	



BASI A TERRA CON ZOCCOLO H. 10 O SOSPESE CON BARRA DI SOSTEGNO. Specificare al momento dell'ordine.
 Il prezzo dello zoccolo o della barra di sostegno è compreso nel prezzo del mobile.
 FLOOR WASHBASIN UNITS WITH BASE H. 10 OR SUSPENDED WITH SUPPORT BAR. Specify when ordering.
 The price of the base or the support bar is included in the unit price.

BASI PORTALAVATRICE, LARGHEZZA 70 CM - PROFONDITÀ 50/60 CM
WASHING-MACHINE UNIT BASES, WIDTH 70 CM - DEPTH 50/60 CM

ESEMPIO DI MONTAGGIO IN COMPOSIZIONE CON PORTALAVATRICE H. 83,4
 EXAMPLE OF ASSEMBLY IN COLLECTION WITH WASHING-MACHINE UNIT H. 83.4

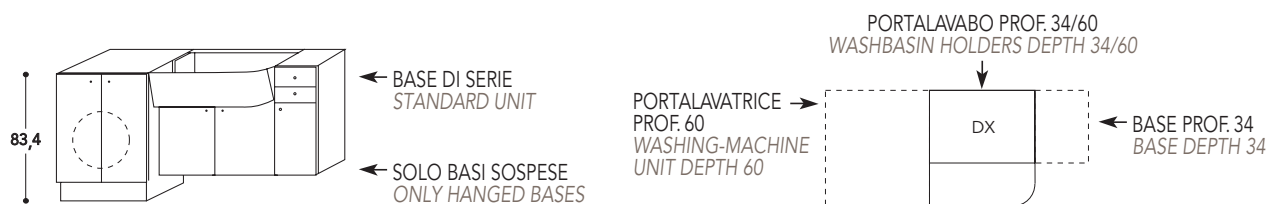

BASI PORTALAVATRICE
 WASHING-MACHINE UNIT

Misure interne utili per lavatrice	Profondità (cm)	Articolo	Prezzo
Useful internal measurements for washing-machine	Depth (cm)	Code	Price

Altezza fianchi / Sides height 83,4 cm

 base portalavatrice / due ante washing-machine base / two doors	L. 61 P. 46 H. 83 W. 61 D. 46 H. 83	50	LCLB7AD3	€ 584
	L. 61 P. 56 H. 83 W. 61 D. 56 H. 83	60	LCLB3AD3	€ 614

Altezza fianchi / Sides height 192 cm

zoccolo / skirting H. 10

 colonna portalavatrice / quattro ante washing-machine column / four doors	L. 61 P. 56 H. 84 W. 61 D. 56 H. 84	60	LCLC3BD5	€ 1.469
--	--	----	----------	---------

Altezza fianchi / Sides height 70,4 cm

portalavabo P. 60/34 da affiancare alla base portalavatrice P. 60 / due ante
 Washbasin holder D. 60/34 to put beside the washing-machine unit / two doors

	Versione	Profondità (cm)	Articolo	Prezzo
	Version	Depth (cm)	Code	Price
 sospeso hanged	versione destra right version	60/34	DCLN72D2	€ 690
 sospeso hanged	versione sinistra left version	34/60	SCLN72D2	



Il prezzo dello zoccolo o della barra di sostegno è compreso nel prezzo del mobile.
 The price of the base or the support bar is included in the unit price.

COLONNE a terra o sospese, **PROFONDITÀ 34 CM**
 Floor or suspended **COLUMNS, DEPTH 34 CM**

	Apertura	Larghezza (cm)	Articolo	Prezzo
	Opening	Width (cm)	Code	Price

Altezza fianchi / Sides height 192 cm

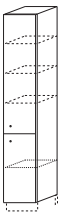
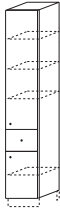
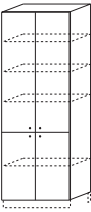
 due ante two doors	cerniere destra right hinges	26,2	DCLC23B5	€ 696
	cerniere sinistra left hinges		SCLC23B5	
	cerniere destra right hinges	35	DCLC23C5	€ 767
	cerniere sinistra left hinges		SCLC23C5	
 due ante / un cassetto two doors / one drawer	cerniere destra right hinges	26,2	DCLC24B5	€ 755
	cerniere sinistra left hinges		SCLC24B5	
	cerniere destra right hinges	35	DCLC24C5	€ 792
	cerniere sinistra left hinges		SCLC24C5	
 quattro ante four doors	-	52,5	LCLC2HN5	€ 1.241
	-	70	LCLC2HD5	€ 1.368



COLONNE A TERRA CON ZOCCOLO H. 10 O SOSPESSE CON BARRA DI SOSTEGNO. Specificare al momento dell'ordine.
 Il prezzo dello zoccolo o della barra di sostegno è compreso nel prezzo del mobile.
 FLOOR COLUMN WITH BASE H. 10 OR SUSPENDED WITH SUPPORT BAR. Specify when ordering.
 The price of the base or the support bar is included in the unit price.

PENSILI CON VANETTO, **ALTEZZA 113,6 CM - PROFONDITÀ 16,2 CM** da affiancare a specchi h. 113,6 cm
 WALL UNITS, **HEIGHT 113,6 CM - DEPTH 16,2 CM** to combine with mirrors h. 113.6 cm

ESEMPIO DI COMPOSIZIONE / EXAMPLE OF COMPOSITION

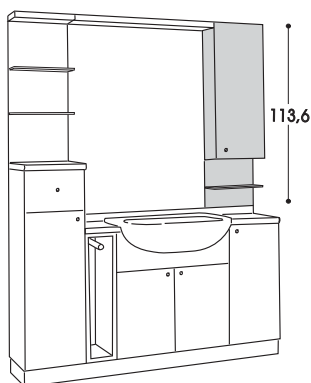

Apertura	Larghezza (cm)	Articolo	Prezzo
Opening	Width (cm)	Code	Price

Altezza / Height 113,6 cm

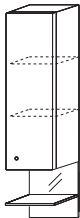
 <p>un'anta h. 83,2 / una mensola a vetro schiena a specchio one door h. 83,2 / one glass shelf back of the cabinet made in mirror</p>	cerniere destra right hinges	26,2	DCLPA5B8	€ 328
	cerniere sinistra left hinges		SCLPA5B8	
	cerniere destra right hinges	35	DCLPA5C8	€ 377
	cerniere sinistra left hinges		SCLPA5C8	

PENSILI, **ALTEZZA 83,2 CM - PROFONDITÀ 18,5 CM** da affiancare a specchi h. 83,2 cm
 WALL UNITS, **HEIGHT 83,2 CM - DEPTH 18,5 CM** to combine with mirrors h. 83.2 cm

Apertura	Larghezza (cm)	Articolo	Prezzo
Opening	Width (cm)	Code	Price

Altezza / Height 83,2 cm

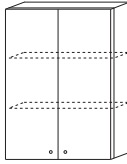
 <p>un'anta one door</p>	cerniere destra right hinges	26,2	DCLPA1B6	€ 254
	cerniere sinistra left hinges		SCLPA1B6	
	cerniere destra right hinges	35	DCLPA1C6	€ 316
	cerniere sinistra left hinges		SCLPA1C6	
 <p>due ante one alu. prof. door+glass</p>	-	52,5	LCLPA2E6	€ 481
	-	70	LCLPA2D6	€ 554

VANETTI A SPECCHIO con mensole in vetro, **PROFONDITÀ 16,2 CM**
 MIRROR COMPARTMENTS with glass shelves, **DEPTH 16,2 CM**

VANETTI
COMPARTMENTS

ESEMPIO DI COMPOSIZIONE / EXAMPLE OF COMPOSITION

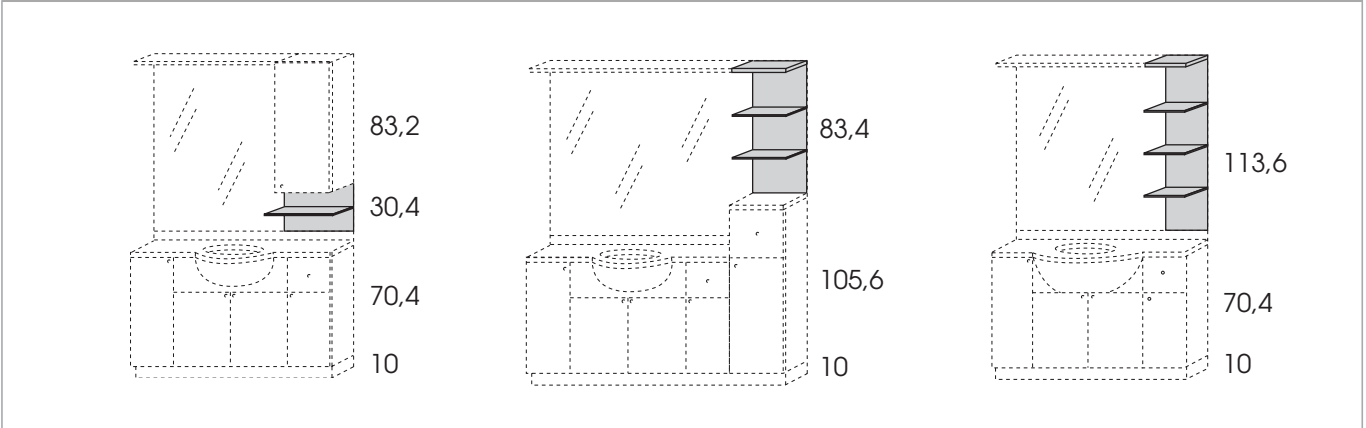

	Larghezza (cm)	Articolo	Prezzo
	Width (cm)	Code	Price

Altezza / Height 30,4 cm

 a specchio / una mensola vetro mirror / one glass shelf	26,2	LC1V11BB	€ 78
	35	LC1V11CB	€ 86
	52,5	LC1V11EB	€ 107
	70	LC1V11DB	€ 119

Altezza / Height 83,4 cm

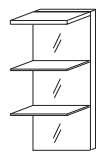
 a specchio / due mensole vetro mensola superiore laccata mirror / two glass shelves top laquered shelf	26,2	LC6V21B4	€ 252
	35	LC6V21C4	€ 278

Altezza / Height 113,6 cm

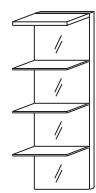
 a specchio / tre mensole vetro mensola superiore laccata mirror / three glass shelves top laquered shelf	17,5	LC6V31AC	€ 261
	26,2	LC6V31BC	€ 289
	35	LC6V31CC	€ 315

SPECCHI DA APPOGGIO con pensile e mensola superiore con faretti, **ALTEZZA 113,6 CM - PROF. 16,2 CM**
 TABLETOP MIRRORS with wall cabinet and top shelf with spotlights, **HEIGHT 113,6 CM - DEPTH 16,2 CM**

	Posizione pensile	Dimensione pensile	N. faretti	Larghezza (cm)	Articolo	Prezzo
	<i>Hanging unit position</i>	<i>Hanging unit dimension</i>	<i>N. lights</i>	<i>Width (cm)</i>	<i>Code</i>	<i>Price</i>

Altezza / Height 113,6 cm

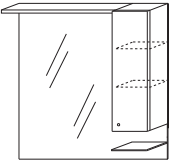
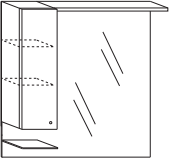
 un'anta / una mensola vetro <i>one door / one glass shelf</i>	pensile a dx <i>right wall unit</i>	26,2	3	122,5	DCLS7DIA	€ 811
		35	3	140	DCLS7DKA	€ 890
 un'anta / una mensola vetro <i>one door / one glass shelf</i>	pensile a sx <i>left wall unit</i>	26,2	3	122,5	SCLS7DIA	€ 811
		35	3	140	SCLS7DKA	€ 890

FARETTO ALOGENO / HALOGEN SPOT LIGHT

Descrizione / Description		INDICARE SEMPRE IL COLORE ALWAYS INDICATE THE COLOUR
 ALOGENO "C"	Colori: cromato, dorato Colours: chrome-plated, gold-plated	Maggiorazione per presa e interruttore internazionale: € 15 netti Supplement for socket + international switch please add € 15 net



Presca interruttore a dx su mensola con faretti
 Socket and switch on light shelf on the right

SPECCHI DA APPOGGIO con mensole vetro e mensola superiore con faretti, **ALTEZZA 113,6 CM - PROF. 16,2 CM**
 TABLETOP MIRRORS with glass shelves and top shelf with spotlights, **HEIGHT 113,6 CM - DEPTH 16,2 CM**

	Posizione mensole vetro	Dimensione mensole vetro	N. faretti	Larghezza (cm)	Articolo	Prezzo
	Glass shelves position	Glass shelves dimension	N. lights	Width (cm)	Code	Price

Altezza / Height 113,6 cm

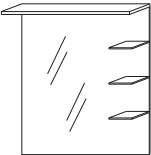
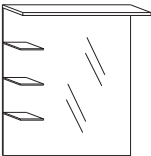
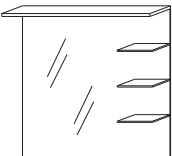
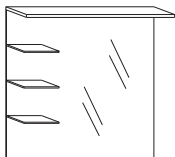
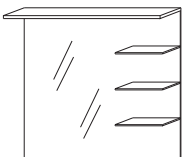
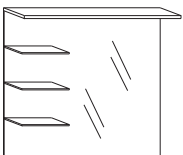
 tre mensole vetro three glass shelves	mensole a dx right shelves	17,5	2	87,5	DC2S74EA	€ 545
			3	96,2	DC2S74MA	€ 548
			3	105	DC2S74GA	€ 567
			3	113,7	DC2S74RA	€ 640
 tre mensole vetro three glass shelves	mensole a sx left shelves	17,5	2	87,5	SC2S74EA	€ 545
			3	96,2	SC2S74MA	€ 548
			3	105	SC2S74GA	€ 567
			3	113,7	SC2S74RA	€ 640
 tre mensole vetro three glass shelves	mensole a dx right shelves	26,2	3	96,2	DC2S74FA	€ 603
			3	122,5	DC2S74IA	€ 673
 tre mensole vetro three glass shelves	mensole a sx left shelves	26,2	3	96,2	SC2S74FA	€ 603
			3	122,5	SC2S74IA	€ 673
 tre mensole vetro three glass shelves	mensole a dx right shelves	35	3	105	DC2S74NA	€ 662
			4	131,2	DC2S74JA	€ 679
			4	140	DC2S74KA	€ 742
 tre mensole vetro three glass shelves	mensole a sx left shelves	35	3	105	SC2S74NA	€ 662
			4	131,2	SC2S74JA	€ 679
			4	140	SC2S74KA	€ 742

FARETTO ALOGENO / HALOGEN SPOT LIGHT

Descrizione / Description	INDICARE SEMPRE IL COLORE ALWAYS INDICATE THE COLOUR
 ALOGENO "C" Colori: cromato, dorato Colours: chrome-plated, gold-plated	Maggiorazione per presa e interruttore internazionale: € 15 netti Supplement for socket + international switch please add € 15 net



Presca interruttore a dx su mensola con faretti
 Socket and switch on light shelf on the right

SPECCHI DA APPOGGIO con mensola superiore laccata con faretti, **ALTEZZA 113,6 CM - PROF. 16,2 CM**
 TABLETOP MIRRORS with lacquered top shelves with spotlights, **HEIGHT 113,6 CM - DEPTH 16,2 CM**

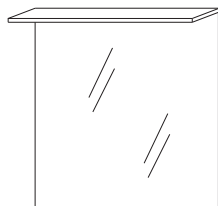

presa interruttore a dx su mensola con faretti
 socket and switch on light shelf on the right

Larghezza Width	70	87,5	96,2	105	113,7	122,5	131,2	140	148,7	157,5	166,2
N. faretti N. lights	2	2	3	3	3	3	4	4	4	5	5
Articolo Code	LC2S79CA	LC2S79EA	LC2S79FA	LC2S79GA	LC2S79HA	LC2S79IA	LC2S79JA	LC2S79KA	LC2S79LA	LC2S79MA	LC2S79NA
Prezzo Price	€ 433	€ 489	€ 516	€ 531	€ 592	€ 620	€ 627	€ 704	€ 780	€ 887	€ 963

SPECCHI SOSPESI con mensole laccate - mensola superiore con faretti, **ALTEZZA 83,2 CM - PROF. 16,2 CM**
 HANGING MIRRORS with lacquered shelves - top shelf with spotlights, **HEIGHT 83,2 CM - DEPTH 16,2 CM**

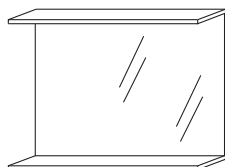

presa interruttore a dx su mensola con faretti
 socket and switch on light shelf on the right

Larghezza Width	70	87,5	96,2	105	113,7	122,5	131,2	140
N. faretti N. lights	2	2	3	3	3	3	4	4
Articolo Code	LC2SCGCF	LC2SCGEF	LC2SCGFF	LC2SCGGF	LC2SCGHF	LC2SCGIF	LC2SCGJF	LC2SCGKF
Prezzo Price	€ 490	€ 544	€ 607	€ 631	€ 702	€ 725	€ 753	€ 810

FARETTO ALOGENO / HALOGEN SPOT LIGHT

Descrizione / Description	 ALOGENO "C" Colori: cromato, dorato Colours: chrome-plated, gold-plated	INDICARE SEMPRE IL COLORE ALWAYS INDICATE THE COLOUR Maggiorazione per presa e interruttore internazionale: € 15 netti Supplement for socket + international switch please add € 15 net
---------------------------	--	--

SPECCHIO "LIBERTY" con cornice patinata, **ALTEZZA 120 CM**
 MIRROR "LIBERTY" with coated frame, **HEIGHT 120 CM**

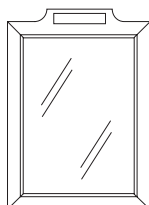

Larghezza Width	92	118
Articolo Code	LCLS51F6	LCLS51G6
Prezzo Price	€ 568	€ 594

LAMPADA A INCANDESCENZA
 INCANDESCENT LAMP

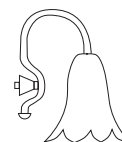

fissaggio cornice
 frame-mounted

Finitura cromo o oro - 40 W Chrome or gold finishing - 40 W	
Articolo Code	LC0A4744
Prezzo Price	€ 107 cad.



PER SPECCHI LISCI E SPECCHIERE VEDI SEZIONE SPECCHI da pag. 180
 FOR SMOOTH MIRRORS AND MIRRORS SEE THE MIRROR'S SECTION from page. 180

TOP VETRO EXTRACHIARO E VETRO EXTRACHIARO SATINATO EXTRACLEAR AND EXTRACLEAR SATIN GLASS TOP

BIANCO



extrachiaro / *extraclear* C1
satinato / *satin* IF

NERO



extrachiaro / *extraclear* C2
satinato / *satin* IG

ARAGOSTA



extrachiaro / *extraclear* C3
satinato / *satin* IH

RUBINO



extrachiaro / *extraclear* C4
satinato / *satin* LP

GIACINTO



extrachiaro / *extraclear* C5
satinato / *satin* IK

LAVANDA



extrachiaro / *extraclear* C6
satinato / *satin* IL

SENAPE



extrachiaro / *extraclear* C7
satinato / *satin* IM

LIME



extrachiaro / *extraclear* C8
satinato / *satin* IN

TURCHINO

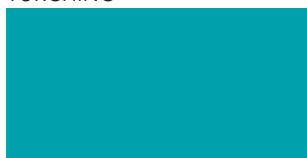

extrachiaro / *extraclear* C9
satinato / *satin* IP

ARTICO



extrachiaro / *extraclear* CA
satinato / *satin* IQ

FUCILE



extrachiaro / *extraclear* CB
satinato / *satin* IR

CORTECCIA



extrachiaro / *extraclear* CC
satinato / *satin* IS

TERRA



extrachiaro / *extraclear* CD
satinato / *satin* IT

IUTA



extrachiaro / *extraclear* CE
satinato / *satin* IU

PERLA



extrachiaro / *extraclear* CF
satinato / *satin* IW

PLATINO



extrachiaro / *extraclear* CG
satinato / *satin* IX

TITANIO



extrachiaro / *extraclear* CL
satinato / *satin* LM

UMBRA

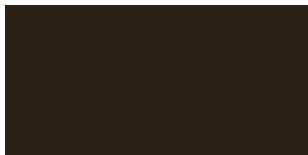

extrachiaro / *extraclear* CM
satinato / *satin* LN

Il top vetro extrachiaro satinato viene fornito con trattamento antimacchia.

RAL MARK-UP: RAL matt and shiny lacquered colors, available on request with 15% additional charge.

TOP TECNORIL TECNORIL TOP

BIANCO OPACO
MATT WHITE



D2

TOP MARMO
MARBLE TOP

gruppo
group

A

MARMO CARRARA



71

TOP MARMORESINA
MARBLERESIN TOP

BOTTICINO



HJ

BIANCO AOSTA



HK

PERLINO ROSATO



HR

ROSSO ASIAGO

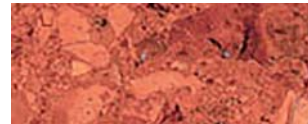

PK

PERLATO APPIA

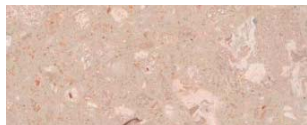

KA

TOP MARMO
MARBLE TOP

gruppo
group

B

VERDE GUATEMALA



64

CALACATTA



32

TOP MARMORESINA
MARBLERESIN TOP

POLARE

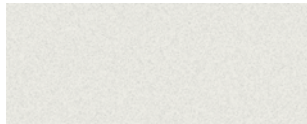

LX

SOLE

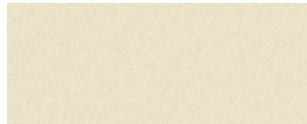

LY

AIDA WHITE



M6

TOP QUARZO
QUARTZ TOP

gruppo
group

D

ICE



HD

GREY



HL

BLUE



HE

NERO



K4

BEIGE ARENA SPAZZOLATO



M3

SPACCATO VULCANO



K7

SPACCATO PHUKET



K6

SPACCATO GUAM

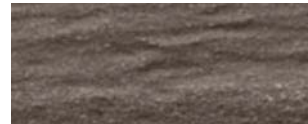

K5

REGOLE PER I PIANI TOP

RULES FOR TOP

COSA COMUNICARE AL MOMENTO DELL'ORDINE

WHAT TO COMMUNICATE WHEN ORDERING

- 1** TIPO DI LAVABO che si intende installare: semincasso, sottopiano.
TYPE OF SINK you want to install: semi-recessed, undercounter.
- 2** NOME DEL LAVABO ED AZIENDA PRODUTTRICE (se si conosce) oppure inviare direttamente il lavabo o la dima reale in scala 1:1
NAME OF SINK AND MANUFACTURER (if known) or send directly the sink or the real template 1:1 scale
- 3** TIPO DI MARMO a cui corrisponde un gruppo di prezzo, ad esempio: Carrara - Gruppo A
TYPE OF MARBLE that correspond a group of price, for example: Carrara - Group A
- 4** PIANI FUORI SQUADRA è obbligatorio inviare dima reale, scala 1:1
NOT RIGHT ANGLED TOPS: real template 1:1 scale is required



LAVORAZIONE DEI PIANI

TOP'S SHAPES

SPESSORE DEL PIANO IN VETRO EXTRACHIARO E EXTRACHIARO SATINATO: 1 cm
EXTRA CLEAR COLOURED GLASS TOP AND EXTRA CLEAR SATIN GLASS TOP THICKNESS : 1 cm

LAVORAZIONE PIANO IN VETRO SPESS. 1 cm <i>GLASS TOP PROCESSING THICKNESS 1 cm</i>		Sagoma / Shape "FILO LUCIDO" (LAD)
--	--	------------------------------------

SPESSORE DEL PIANO IN MARMO, MARMORESINA, QUARZO: 2 cm
MARBLE, MARBLE RESIN, QUARTZ TOPS THICKNESS: 2 cm

LAVORAZIONE PIANO GRUPPI A, B, D SPESS. 2 cm <i>GROUPS A, B, D TOP PROCESSING THICKNESS 2 cm</i>		Sagoma / Shape "MEZZO TORO" (LA9)
		Sagoma / Shape "CLASSICA" (LA6)

I PREZZI INDICATI NEL PRESENTE LISTINO COMPRENDONO 1 FORO LAVABO
THE PRICES SHOWN IN THIS PRICE LIST INCLUDE A SINK HOLE

ALTRE INFORMAZIONI UTILI

OTHER USEFUL INFORMATION

		
ATTENZIONE: a partire da L.166,2 cm i piani per lavabo semincasso soprapiano verranno forniti in due pezzi, tagliati nel centro del foro lavabo <i>Please note that from L.166, 2 cm, tops for semi-recessed washbasin will be provided in two pieces, cut in the center of the sink hole</i>	PIANI CON TAGLIO CAMBIO DI PROFONDITÀ non viene applicata nessuna maggiorazione di prezzo <i>Top with changing depth, no overcharge applied</i>	ALZATINE DI LUNGHEZZA SUPERIORE A 166,2 CM verranno fornite in due pezzi. L'alzata verrà divisa esattamente a metà salvo diversa indicazione specificata nell'ordine <i>Backsplashes longer than 166,2 will be provided in 2 pieces. The backsplash is divided in half unless otherwise specified in the order</i>

TOP PER BASI PORTALAVABO SEMINCASSO - PROFONDITÀ 34 CM
TOP FOR SEMI-RECESSED WASHBASIN UNIT BASES - DEPTH 34 CM

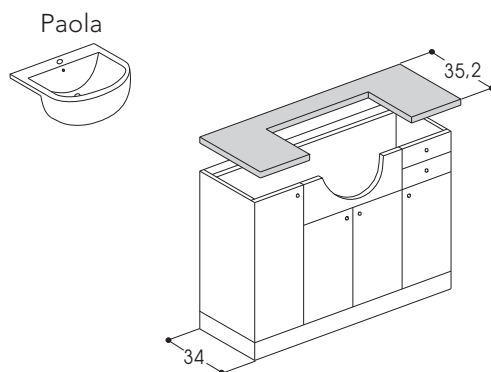

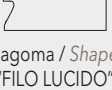
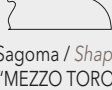
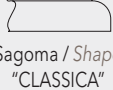
Lunghezza (cm)	Articolo	Vetro extrachiaro colorato	Vetro extrachiaro satinato colorato	Articolo	Articolo	Gruppo A	Gruppo B	Gruppo D
Length (cm)	Code	Extraclear colored glass	Extraclear satin colored glass	Code	Code	A group	B group	D group
	 Sagoma / Shape "FILO LUCIDO"	Sp. / Thick. 1 cm		 Sagoma / Shape "MEZZO TORO"	 Sagoma / Shape "CLASSICA"	Spessore / Thickness 2 cm		
		Fascia di Prezzo / Price range				Fascia di Prezzo / Price range		
		1	2			3	4	6
70	LADT0508	€ 338	€ 575	LA9T0508	LA6T0508	€ 162	€ 243	€ 392
87,5	LADT0510	€ 360	€ 598	LA9T0510	LA6T0510	€ 197	€ 298	€ 484
96,2	LADT0511	€ 375	€ 612	LA9T0511	LA6T0511	€ 214	€ 325	€ 530
105	LADT0512	€ 390	€ 627	LA9T0512	LA6T0512	€ 228	€ 356	€ 547
113,7	LADT0513	€ 406	€ 643	LA9T0513	LA6T0513	€ 245	€ 383	€ 590
122,5	LADT0514	€ 412	€ 650	LA9T0514	LA6T0514	€ 261	€ 412	€ 620
131,2	LADT0515	€ 427	€ 664	LA9T0515	LA6T0515	€ 278	€ 441	€ 663
140	LADT0516	€ 442	€ 679	LA9T0516	LA6T0516	€ 294	€ 468	€ 698
148,7	LADT0517	€ 457	€ 694	LA9T0517	LA6T0517	€ 303	€ 484	€ 728
157,5	LADT0518	€ 464	€ 702	LA9T0518	LA6T0518	€ 312	€ 498	€ 768
166,2	LADT0519	€ 479	€ 716	LA9T0519	LA6T0519	€ 328	€ 524	€ 810
175	LADT0520	€ 495	€ 732	LA9T0520	LA6T0520	€ 336	€ 540	€ 852
183,7	LADT0521	€ 513	€ 750	LA9T0521	LA6T0521	€ 345	€ 556	€ 893
192,5	LADT0522	€ 520	€ 757	LA9T0522	LA6T0522	€ 360	€ 581	€ 935
201,2	LADT0523	€ 536	€ 773	LA9T0523	LA6T0523	€ 376	€ 606	€ 976
210	LADT0524	€ 550	€ 788	LA9T0524	LA6T0524	€ 391	€ 632	€ 1.018

ALZATINE / BACKSPLASHES

PREZZO AL METRO LINEARE / PRICE LINEAR METRE

Altezza (cm) Height (cm)	Articolo Code	Vetro extrachiaro colorato	Vetro extrachiaro satinato colorato	Altezza (cm) Height (cm)	Articolo Code	Gruppo A	Gruppo B	Gruppo D
		Extraclear colored glass	Extraclear satin colored glass			A group	B group	D group
		Sp. / Thick. 1 cm				Sp. / Thick. 2 cm		
		Fascia di Prezzo / Price range				Fascia di Prezzo / Price range		
		1	2			3	4	6
7	LADD04.5	€ 86	€ 151	6	LA3D02.4	€ 32	€ 40	€ 104





Aggiunta secondo foro lavabo: € 34 per lavabo semincasso.
 Additional second hole for washbasin: € 34 for semi-recessed washbasin.

TOP PER BASI PORTALAVABO INCASSO TOTALE - PROFONDITÀ 34 CM TOP FOR FULLY-RECESSED WASHBASIN UNIT BASES - DEPTH 34 CM

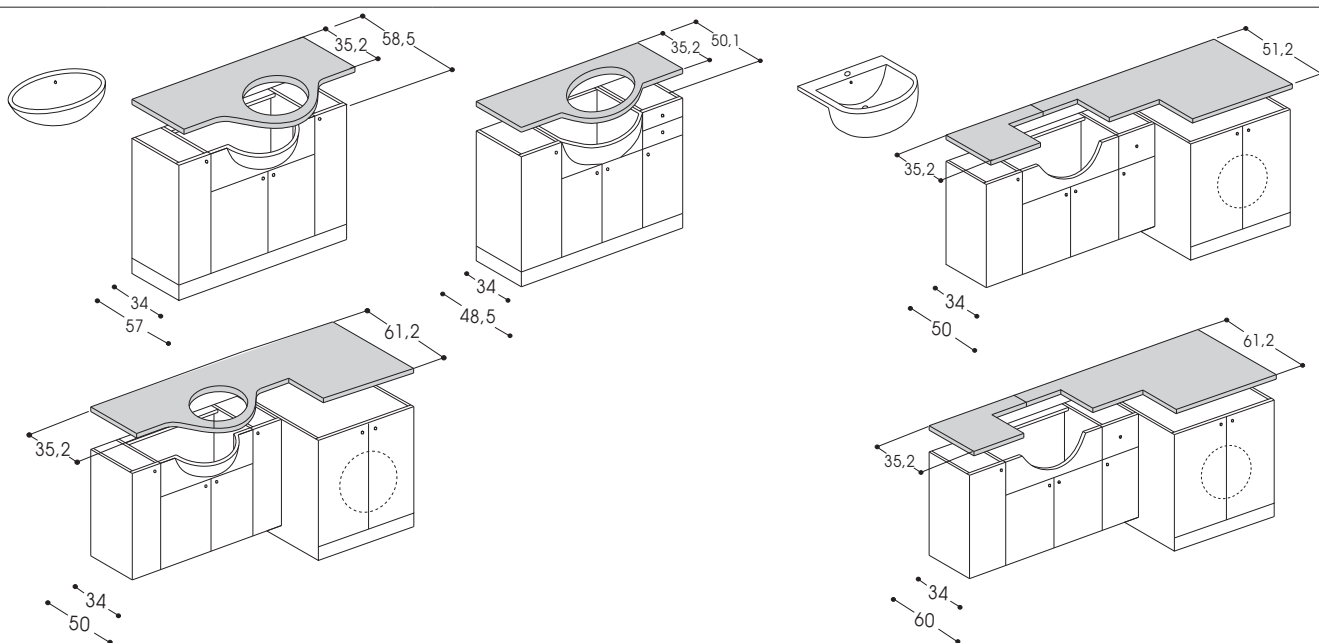
TOP
TOP

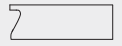

Lunghezza (cm)	Articolo	Vetro extrachiaro colorato	Vetro extrachiaro satinato colorato	Articolo	Articolo	Gruppo A	Gruppo B	Gruppo D
Length (cm)	Code	Extraclear colored glass	Extraclear satin colored glass	Code	Code	A group	B group	D group
		Sp. / Thick. 1 cm				Spessore / Thickness 2 cm		
	Sagoma / Shape "FILO LUCIDO"	Fascia di Prezzo / Price range		Sagoma / Shape "MEZZO TORO"	Sagoma / Shape "CLASSICA"	Fascia di Prezzo / Price range		
		1	2			3	4	6
70	LADT0108	€ 365	€ 602	LA9T0108	LA6T0108	€ 184	€ 322	€ 608
87,5	LADT0110	€ 390	€ 627	LA9T0110	LA6T0110	€ 229	€ 402	€ 760
96,2	LADT0111	€ 412	€ 650	LA9T0111	LA6T0111	€ 252	€ 443	€ 803
105	LADT0112	€ 431	€ 668	LA9T0112	LA6T0112	€ 288	€ 506	€ 846
113,7	LADT0113	€ 450	€ 687	LA9T0113	LA6T0113	€ 313	€ 548	€ 916
122,5	LADT0114	€ 461	€ 698	LA9T0114	LA6T0114	€ 341	€ 598	€ 959
131,2	LADT0115	€ 479	€ 716	LA9T0115	LA6T0115	€ 365	€ 641	€ 1.027
140	LADT0116	€ 498	€ 736	LA9T0116	LA6T0116	€ 394	€ 689	€ 1.078
148,7	LADT0117	€ 520	€ 757	LA9T0117	LA6T0117	€ 409	€ 715	€ 1.119
157,5	LADT0118	€ 528	€ 765	LA9T0118	LA6T0118	€ 423	€ 741	€ 1.184
166,2	LADT0119	€ 550	€ 788	LA9T0119	LA6T0119	€ 446	€ 782	€ 1.250
175	LADT0120	€ 568	€ 806	LA9T0120	LA6T0120	€ 453	€ 794	€ 1.310
183,7	LADT0121	€ 588	€ 825	LA9T0121	LA6T0121	€ 476	€ 834	€ 1.375
192,5	LADT0122	€ 598	€ 835	LA9T0122	LA6T0122	€ 498	€ 873	€ 1.441
201,2	LADT0123	€ 617	€ 854	LA9T0123	LA6T0123	€ 521	€ 913	€ 1.506
210	LADT0124	€ 635	€ 872	LA9T0124	LA6T0124	€ 544	€ 954	€ 1.572

ALZATINE / BACKSPASHES

PREZZO AL METRO LINEARE / PRICE LINEAR METRE

Altezza (cm) Height (cm)	Articolo Code	Vetro extrachiaro colorato	Vetro extrachiaro satinato colorato	Altezza (cm) Height (cm)	Articolo Code	Gruppo A	Gruppo B	Gruppo D	
		Extraclear colored glass	Extraclear satin colored glass			A group	B group	D group	
		Sp. / Thick. 1 cm				Sp. / Thick. 2 cm			
Fascia di Prezzo / Price range		Fascia di Prezzo / Price range							
1		2		3			4		6
7	LADD04.5	€ 86	€ 151	6	LA3D02.4	€ 32	€ 40	€ 104	



Aggiunta secondo foro lavabo: € 34 per lavabo semincasso, € 95 per lavabo incasso totale.
Additional second hole for washbasin: € 34 for semi-recessed washbasin, € 95 for fully-recessed washbasin.

TOP PER BASI PORTALAVABO INCASSO TOTALE PROF. 34 CM E BASE PORTALAVATRICE PROF. 60 CM
TOP FOR FULLY-RECESSED WASHBASIN UNIT BASES - DEPTH 34 CM

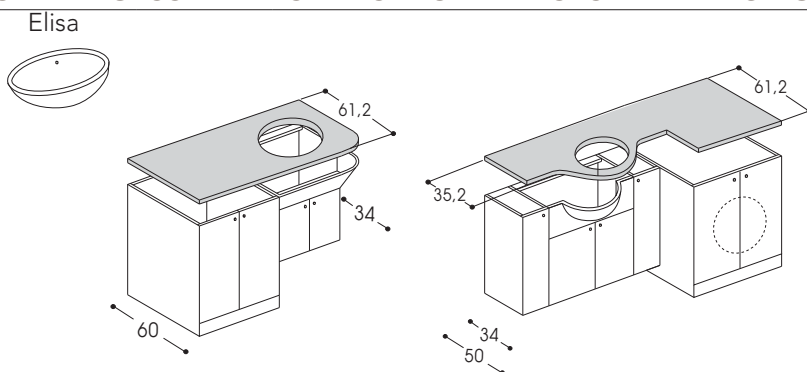

Lunghezza (cm)	Articolo	Vetro extrachiaro colorato	Vetro extrachiaro satinato colorato	Articolo	Articolo	Gruppo A	Gruppo B	Gruppo D
Length (cm)	Code	Extraclear colored glass	Extraclear satin colored glass	Code	Code	A group	B group	D group
	 Sagoma / Shape "FILO LUCIDO"	Sp. / Thick. 1 cm		 Sagoma / Shape "MEZZO TORO"	 Sagoma / Shape "CLASSICA"	Spessore / Thickness 2 cm		
		Fascia di Prezzo / Price range				Fascia di Prezzo / Price range		
		1	2			3	4	6
140	LADT0616	€ 498	€ 736	LA9T0616	LA6T0616	€ 436	€ 763	€ 1.167
148,7	LADT0617	€ 520	€ 757	LA9T0617	LA6T0617	€ 453	€ 793	€ 1.219
166,2	LADT0619	€ 550	€ 788	LA9T0619	LA6T0619	€ 494	€ 864	€ 1.322
175	LADT0620	€ 568	€ 806	LA9T0620	LA6T0620	€ 511	€ 879	€ 1.371
183,7	LADT0621	€ 588	€ 825	LA9T0621	LA6T0621	€ 527	€ 922	€ 1.418
192,5	LADT0622	€ 598	€ 835	LA9T0622	LA6T0622	€ 551	€ 966	€ 1.486
201,2	LADT0623	€ 617	€ 854	LA9T0623	LA6T0623	€ 576	€ 1.010	€ 1.554
210	LADT0624	€ 635	€ 872	LA9T0624	LA6T0624	€ 601	€ 1.054	€ 1.622

ALZATINE / BACKSPASHES

PREZZO AL METRO LINEARE / PRICE LINEAR METRE

Altezza (cm) Height (cm)	Articolo Code	Vetro extrachiaro colorato Extraclear colored glass	Vetro extrachiaro satinato colorato Extraclear satin colored glass	Altezza (cm) Height (cm)	Articolo Code	Gruppo A A group	Gruppo B B group	Gruppo D D group
		Sp. / Thick. 1 cm				Sp. / Thick. 2 cm		
		Fascia di Prezzo / Price range				Fascia di Prezzo / Price range		
		1	2			3	4	6
7	LADD04.5	€ 86	€ 151	6	LA3D02.4	€ 32	€ 40	€ 104



Aggiunta secondo foro lavabo: € 95 per lavabo incasso totale.
 Additional second hole for washbasin: € 95 for fully-recessed washbasin.

TOP LINEARI PER BASI - PROFONDITÀ 34 CM
LINEAR TOP FOR BASES - DEPTH 34 CM

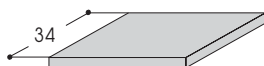

Lunghezza (cm)	Articolo	Vetro extrachiaro colorato	Vetro extrachiaro satinato colorato	Articolo	Articolo	Gruppo A	Gruppo B	Gruppo D
Length (cm)	Code	Extraclear colored glass	Extraclear satin colored glass	Code	Code	A group	B group	D group
	 Sagoma / Shape "FILO LUCIDO"	Sp. / Thick. 1 cm		 Sagoma / Shape "MEZZO TORO"	 Sagoma / Shape "CLASSICA"	Spessore / Thickness 2 cm		
		Fascia di Prezzo Price range				Fascia di Prezzo Price range		
		1	2			3	4	6
17,5	LADT0C02	€ 107	€ 345	LA9T0C02	LA6T0C02	€ 63	€ 90	€ 140
26,2	LADT0C03	€ 119	€ 356	LA9T0C03	LA6T0C03	€ 73	€ 105	€ 159
35	LADT0C04	€ 130	€ 367	LA9T0C04	LA6T0C04	€ 82	€ 120	€ 179
52,5	LADT0C06	€ 153	€ 390	LA9T0C06	LA6T0C06	€ 124	€ 179	€ 268
70	LADT0C08	€ 179	€ 416	LA9T0C08	LA6T0C08	€ 139	€ 220	€ 370
87,5	LADT0C10	€ 197	€ 434	LA9T0C10	LA6T0C10	€ 174	€ 276	€ 461
96,2	LADT0C11	€ 208	€ 445	LA9T0C11	LA6T0C11	€ 191	€ 303	€ 507
105	LADT0C12	€ 223	€ 460	LA9T0C12	LA6T0C12	€ 206	€ 333	€ 524

TOP LINEARE PER BASE PORTALAVATRICE - PROFONDITÀ 50 CM
LINEAR TOP FOR WASHING-MACHINE UNIT BASE - DEPTH 50 CM

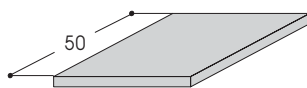

Lunghezza (cm)	Articolo	Vetro extrachiaro colorato	Vetro extrachiaro satinato colorato	Articolo	Articolo	Gruppo A	Gruppo B	Gruppo D
Length (cm)	Code	Extraclear colored glass	Extraclear satin colored glass	Code	Code	A group	B group	D group
	 Sagoma / Shape "FILO LUCIDO"	Sp. / Thick. 1 cm		 Sagoma / Shape "MEZZO TORO"	 Sagoma / Shape "CLASSICA"	Spessore / Thickness 2 cm		
		Fascia di Prezzo Price range				Fascia di Prezzo Price range		
		1	2			3	4	6
70	LADT0A08	€ 223	€ 460	LA9T0A08	LA6T0A08	€ 160	€ 298	€ 492

TOP LINEARE PER BASE PORTALAVATRICE - PROFONDITÀ 60 CM
LINEAR TOP FOR WASHING-MACHINE UNIT BASE - DEPTH 60 CM

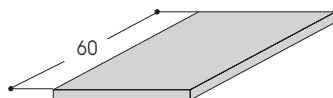

Lunghezza (cm)	Articolo	Vetro extrachiaro colorato	Vetro extrachiaro satinato colorato	Articolo	Articolo	Gruppo A	Gruppo B	Gruppo D
Length (cm)	Code	Extraclear colored glass	Extraclear satin colored glass	Code	Code	A group	B group	D group
	 Sagoma / Shape "FILO LUCIDO"	Sp. / Thick. 1 cm		 Sagoma / Shape "MEZZO TORO"	 Sagoma / Shape "CLASSICA"	Spessore / Thickness 2 cm		
		Fascia di Prezzo Price range				Fascia di Prezzo Price range		
		1	2			3	4	6
70	LADT0D08	€ 223	€ 460	LA9T0D08	LA6T0D08	€ 180	€ 332	€ 521

PIANI CON VASCA INTEGRATA PER BASI PORTALAVABO INCASSO TOTALE - PROF. 34/57 CM
 FULLY RECESSED INTEGRATED WASHBASIN SURFACES FOR RECESSED WASHBASIN UNITS - DEPTH 34/57 CM

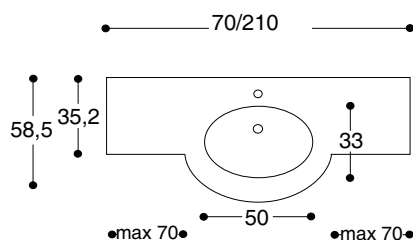

Profondità vasca 13 cm / Basin D. 13 cm
 Senza troppo pieno / Without over-flow

Lunghezza (cm)	Articolo	Vetro extrachiaro colorato	Vetro extrachiaro satinato colorato	Articolo	Tecnoril
Length (cm)	Code	Extraclear colored glass	Extraclear satin colored glass	Code	Tecnoril
	 Sagoma / Shape "FILO LUCIDO"	Sp. / Thick. 1 cm		 Sagoma / Shape "FILO LUCIDO"	Sp. / Thick. 1,2 cm
		Fascia di Prezzo / Price range			Fascia di Prezzo / Price range
		1	2		7
70	LADT7908	€ 838	€ 1.025	LA0T6908	€ 678
87,5	LADT7910	€ 893	€ 1.076	LA0T6910	€ 768
96,2	LADT7911	€ 929	€ 1.111	LA0T6911	€ 814
105	LADT7912	€ 966	€ 1.146	LA0T6912	€ 836
113,7	LADT7913	€ 1.003	€ 1.182	LA0T6913	€ 881
122,5	LADT7914	€ 1.024	€ 1.201	LA0T6914	€ 927
131,2	LADT7915	€ 1.058	€ 1.233	LA0T6915	€ 972
140	LADT7916	€ 1.090	€ 1.264	LA0T6916	€ 994
148,7	LADT7917	€ 1.131	€ 1.304	LA0T6917	€ 1.040
157,5	LADT7918	€ 1.148	€ 1.320	LA0T6918	€ 1.085
166,2	LADT7919	€ 1.190	€ 1.358	LA0T6919	€ 1.130
175	LADT7920	€ 1.223	€ 1.390	LA0T6920	€ 1.153
183,7	LADT7921	€ 1.255	€ 1.422	LA0T6921	€ 1.198
192,5	LADT7922	€ 1.276	€ 1.442	LA0T6922	€ 1.243
201,2	LADT7923	€ 1.313	€ 1.477	LA0T6923	€ 1.288
210	LADT7924	€ 1.347	€ 1.509	LA0T6924	€ 1.311

ALZATINE / BACKSPLASHES

PREZZO AL METRO LINEARE / PRICE LINEAR METRE

Altezza (cm)	Articolo	Vetro extrachiaro colorato	Vetro extrachiaro satinato colorato	Altezza (cm)	Articolo	Tecnoril
Height (cm)	Code	Extraclear colored glass	Extraclear satin colored glass	Height (cm)	Code	Tecnoril
		Sp. / Thick. 1 cm				Sp. / Th. 1,2 cm
		Fascia di Prezzo / Price range				Fascia di Prezzo / Price range
		1	2			7
7	LADD04.5	€ 86	€ 151	6,8	LA0D05.A	€ 95